

KLT-K7MF-IMX258 V2.0

13MP Sony IMX258 MIPI Interface Fixed Focus Camera Module

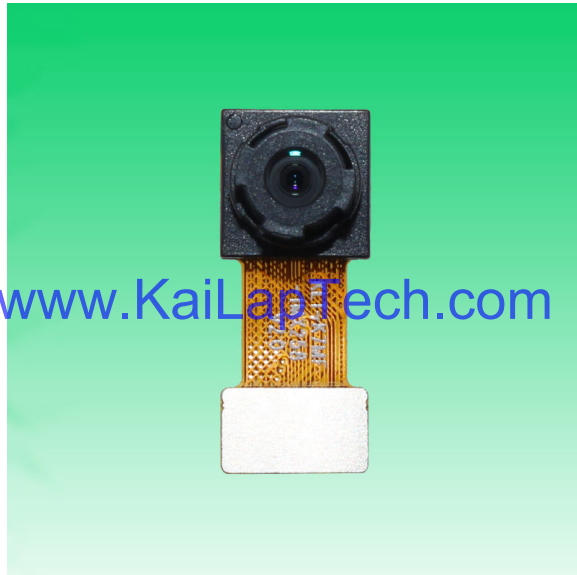

Front View



Back View

Specifications

Camera Module No.	KLT-K7MF-IMX258 V2.0
Resolution	13MP
Image Sensor	IMX258
Sensor Type	1/3.06"
Pixel Size	1.12 um x 1.12 um
EFL	2.35 mm
F.NO	2.40
Pixel	4224 x 3136
View Angle	127.0°(DFOV) 99.5°(HFOV) 70.0°(VFOV)
Lens Dimensions	8.50 x 8.50 x 6.12 mm
Module Size	20.85 x 8.50 mm
Module Type	Fixed Focus
Interface	MIPI
Auto Focus VCM Driver IC	None
Lens Model	KLT-LENS-TK1267
Lens Type	650nm IR Cut
Operating Temperature	-20°C to +70°C
Mating Connector	BBR43-30KB533

**KLT-K7MF-IMX258 V2.0****13MP Sony IMX258 MIPI Interface Fixed Focus Camera Module**

Top View

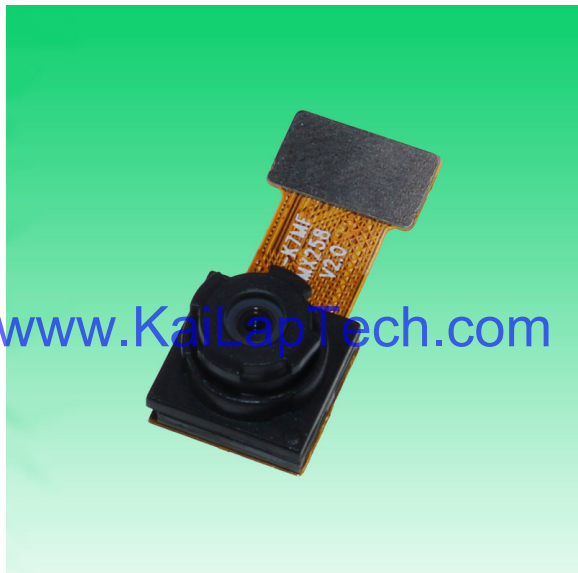

Side View

www.KaiLapTech.comwww.KaiLapTech.com

Bottom View

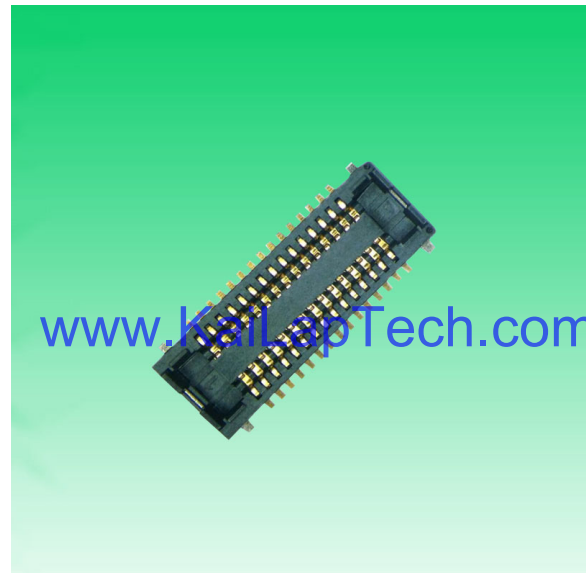

Mating Connector

RoHS

0	SIGNAL
1	GND
2	GND
3	GND
4	GND
5	NC
6	NC
7	SDA
8	DOVDD1.8V
9	SCL
10	DVDD1.2V
11	GND
12	XSHUTDOWN
13	MCN
14	NC
15	MCP
16	GND
17	MDDN
18	MCLK
19	MDOP
20	GND
21	MD1N
22	FLASH
23	MD1P
24	AVDD2.8V
25	VP(NC)
26	AGND
27	MD2N
28	MD3N
29	MD2P
30	MD3P

Version	Information	Date
V1.0	First Version	5-22-2019
V2.0	Change lens and holder	6-2-2020

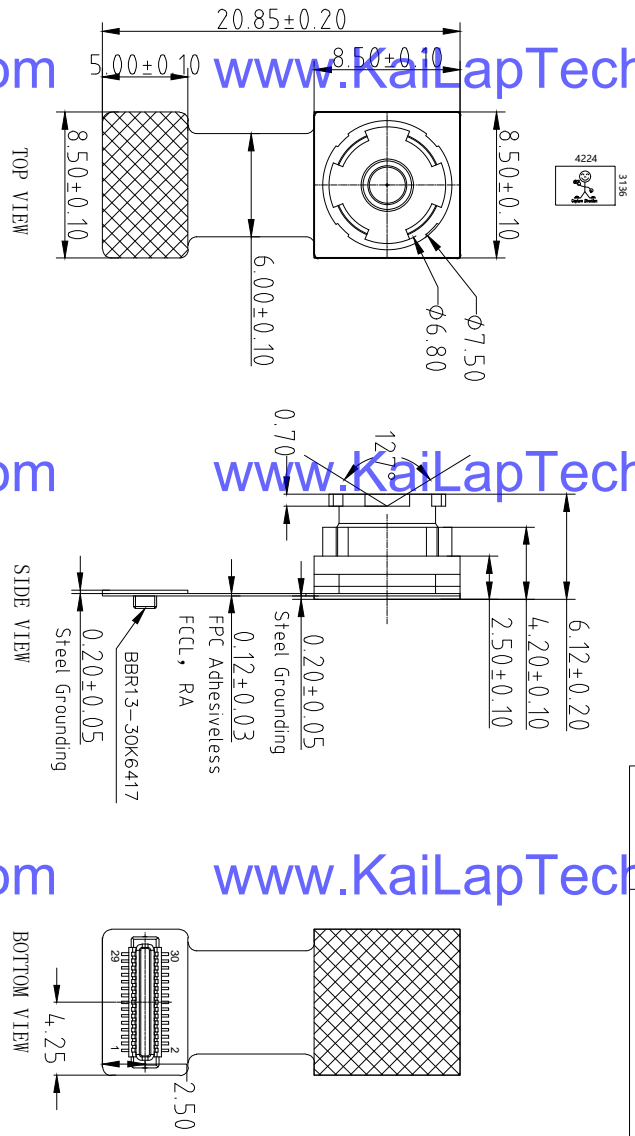

Parameters:

- Sensor specification:**
 - Image Sensor: IMX258
 - Pixel: 1.12um×1.12um
 - Lens Type: 1/3.06
 - Important Voltage Description: DVDD1.2V (external power supply);
- Lens specification:**
 - FOV: 127°(D);99.5°(H);70°(V)
 - F/#/NO.: 2.4
 - TV distortion: <-10.5%
 - Focal length: 2.35mm
 - Composition: 6P+IR FILTER
 - IR Cut Coating: 650nm±10nm@50%

NOTE:

- The device I2C address:0x34;
- Driver IC and its I2C Address:DW9763; 0x18h;

Kai Lap Technologies Group Ltd

Designed By	Kevin	Model Name:	KLT-K7MF-IMX258 V2.0
Checked By	Aouly_Yad	Projection Type:	Third Angle
		Unit:	mm
		Scale:	1:1
		Sheet:	1 of 1
		Version:	1/0



Lens Model: KLT-LENS-TK1267

由 Autodesk 教育版产品制作

COMPOSITION: 6 ELEMENTS, ALL PLASTIC
 SENSOR: 1/3.1" CMOS DIAGONAL=5.7)
 EFL=2.35
 TTL=5.4±0.1 (INFINITY, WITH 0.145mm IR FILM)
 FNO=2.4±5% (INFINITE)
 FIELD OF VIEW
 DIAGONAL: 106° (γ° =2.85)
 TV-DISTORTION (Treaditional)*2) < -10.5%
 RELATIVE TILTNANCE=25% (θγ° =2.85) (Ref.)
 CHIEF RAY ANGLE <33°
 MAXIMUM IMAGE CIRCLE: φ6.05

φ5.80±0.1
 φ6.80±0.1
 50.0±0.4
 6.8±0.1
 106.0°
 4.6
 TTL: 4
 0.81±0.02
 0.70±0.02
 M6.5P0.25

由 Autodesk 教育版产品制作

◎	⚠	III	1:1	材	质		
一般公差							
0							
±0.1							
±0.05							
0.00							
A1							
2019.08.19							
版次							
年.月.日							
内							
新图发行							
作图							
A20							
图号							
A2							
版次							
A2							
图号							
A20							
图号							
A20							
图号							
A20							
图号							
A20							
图号							
A20							
图号							
A20							
图号							
A20							
图号							
A20							
图号							
A20							
图号							
A20							
图号							
A20							
图号							
A20							
图号							
A20							
图号							
A20							
图号							
A20							
图号							
A20							
图号							
A20							
图号							
A20							
图号							
A20							
图号							
A20							
图号							
A20							
图号							
A20							
图号							
A20							
图号							
A20							
图号							
A20							
图号							
A20							
图号							
A20							
图号							
A20							
图号							
A20							
图号							
A20							
图号							
A20							
图号							
A20							
图号							
A20							
图号							
A20							
图号							
A20							
图号							
A20							
图号							
A20							
图号							
A20							
图号							
A20							
图号							
A20							
图号							
A20							
图号							
A20							
图号							
A20							
图号							
A20							
图号							
A20							
图号							
A20							
图号							
A20							
图号							
A20							
图号							
A20							
图号							
A20							
图号							
A20							
图号							
A20							
图号							
A20							
图号							
A20							
图号							
A20							
图号							
A20							
图号							
A20							
图号							
A20							
图号							
A20							
图号							
A20							
图号							
A20							
图号							
A20							
图号							
A20							
图号							
A20							
图号							
A20							
图号							
A20							
图号							
A20							
图号							
A20							
图号							
A20							
图号							
A20							
图号							
A20							
图号							
A20							
图号							
A20							
图号							
A20							
图号							
A20							
图号							
A20							
图号							
A20							
图号							
A20							
图号							
A20							
图号							
A20							
图号							
A20							
图号							
A20							
图号							
A20							
图号							
A20							
图号							
A20							
图号							
A20							
图号							
A20							
图号							
A20							
图号							
A20							
图号							
A20							
图号							
A20							
图号							
A20							
图号							
A20							
图号							
A20							
图号							
A20							
图号							
A20							
图号							
A20							
图号							
A20							
图号							
A20							
图号							
A20							
图号							
A20							
图号							
A20							
图号							
A20							
图号							
A20							
图号							
A20							
图号							
A20							
图号							
A20							

1 2 3 4 5 6 7 8

REV.	EC#	DESCRIPTION	DATE	DRAWN	CHECKED	APPROVED
A	TJECR10018-02	NEW RELEASE PER NPRI 0009	11/05/10	RAIN	DICK, SON	HARDWARE
B	TJECR13014	AXI, AXI	05/13/13	RAIN	Steve M	eng
						Jeff

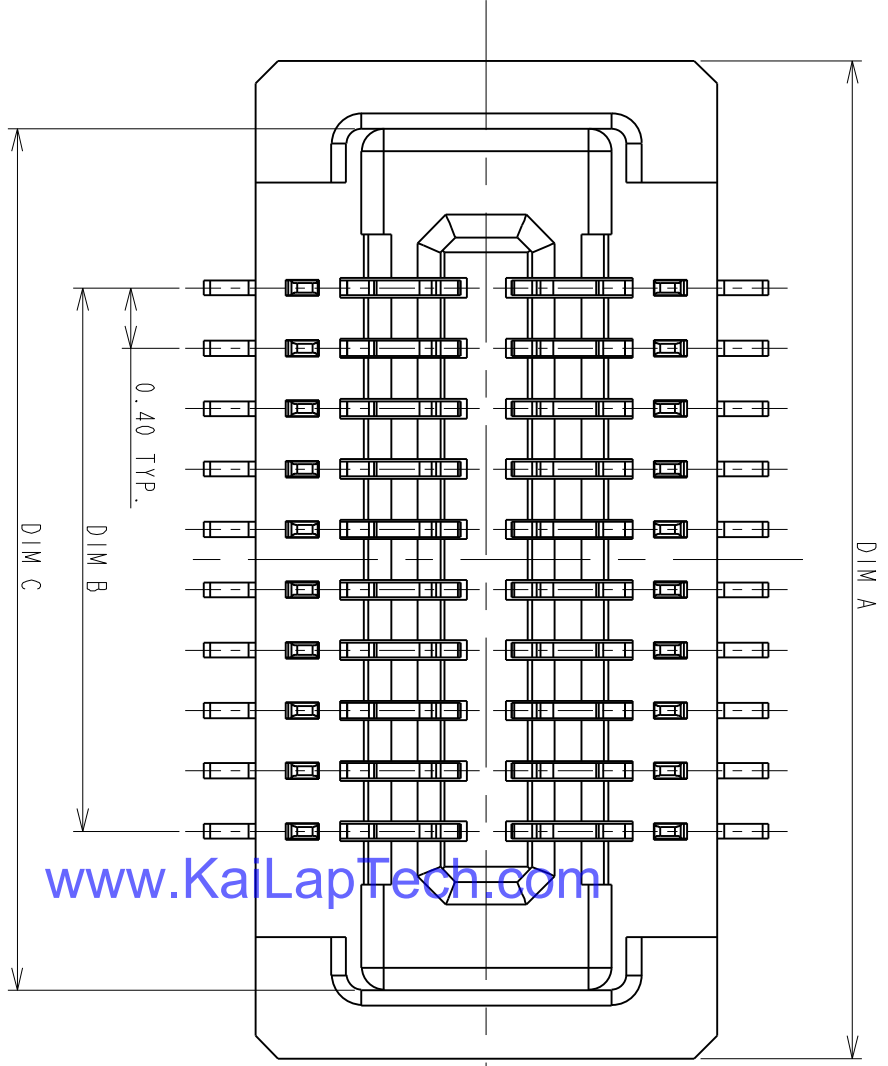

www.KaiLapTech.com

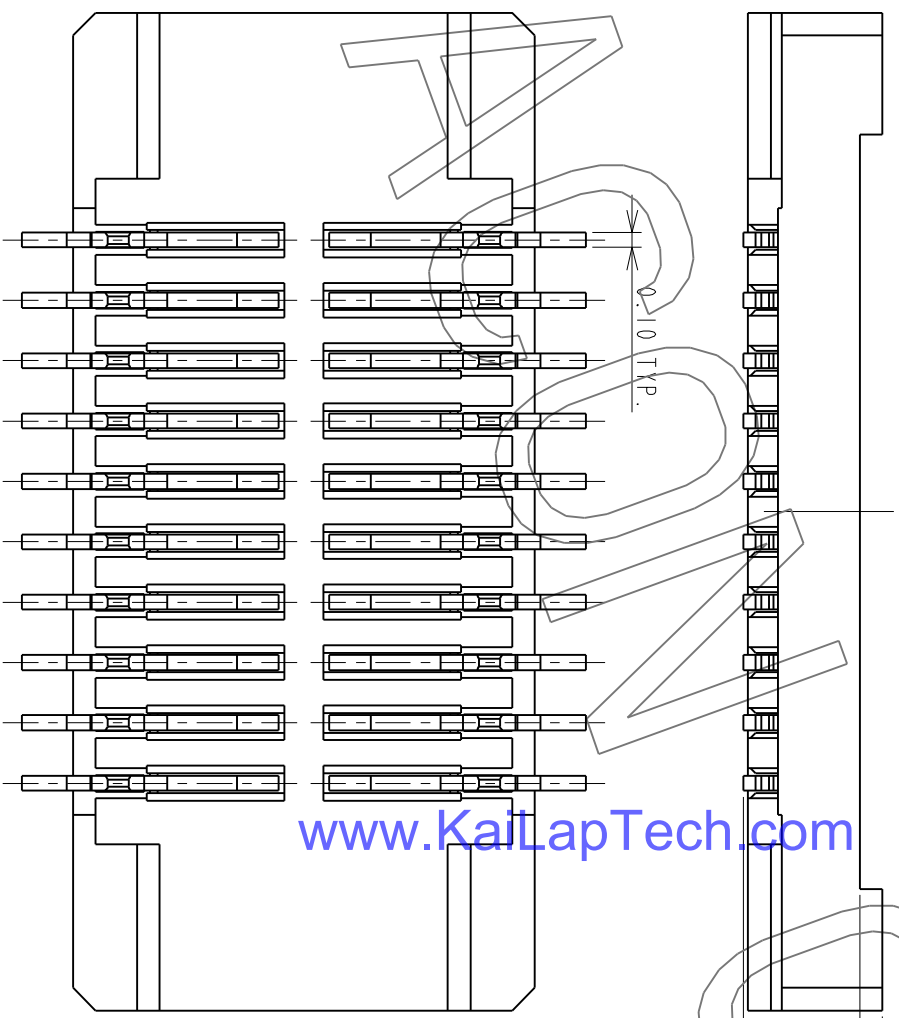

www.KaiLapTech.com

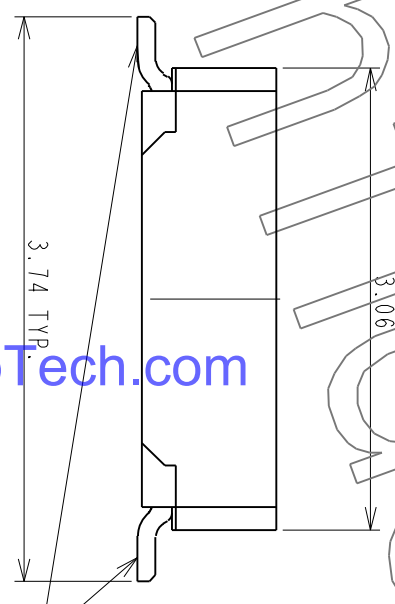

www.KaiLapTech.com

www.KaiLapTech.com

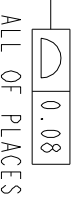
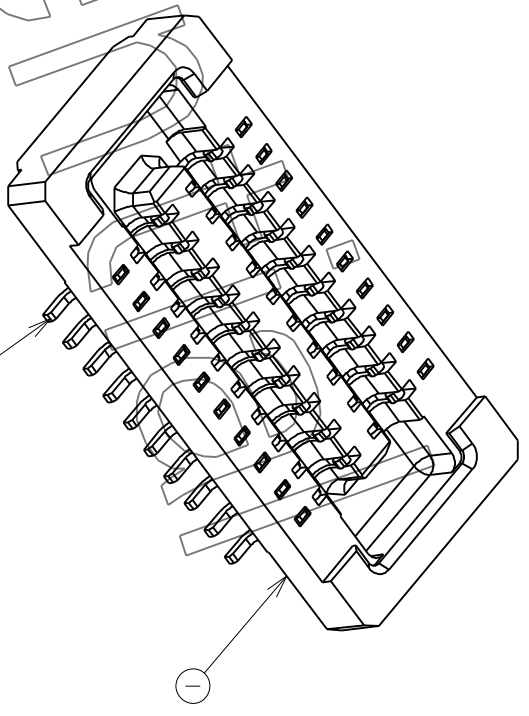

ALL OF PLACES

ITEM	NAME	Q'TY	PART #	MATERIAL / FINISH
2	CONTACT	XX	T-BBR43-100X30	COPPER ALLOY/PLATING GOLD
1	HOUSING	1	I-BBR43-1XXX33	HIGH TEMP RESIN/UL 94 V-0

TOLERANCES UNLESS OTHERWISE SPECIFIED	
GENERAL	±0.38
XX	±0.25
.XXX	±0.05
ANGLES	
X°	±3.0°
.XX°	±1.0°
SCALE 20:1	
SHEET 1 OF 2	
UNIT	MM

DATE	04/15/10	DATE	04/15/10
DRAWN	RAIN	CHECKED	RAIN
DATE	04/15/10	DATE	04/15/10
DESIGN	RAIN	HARDWARE	04/24/10
DATE	04/15/10	APPROVED	DICK, LEE
DATE	04/15/10	DATE	04/24/10

TITLE	P0.4*H1.0mm BOARD TO BOARD
ADVANCED-CONNECTEK INC.	CONN. RECEPTACLE
WITHOUT HOLD DOWN	

SERIES	BBR	SIZE	A3
DWG NO.	C-BBR43-04-01	REV.	B



This document and information contained herein are the property of Advanced Connectek Inc. Copies are issued in strict confidence and shall not be reproduced or copied, or used as the basis of manufacture or sale of apparatus without permission.

All materials meet the ACON's spec. environment-related substances management technical standard

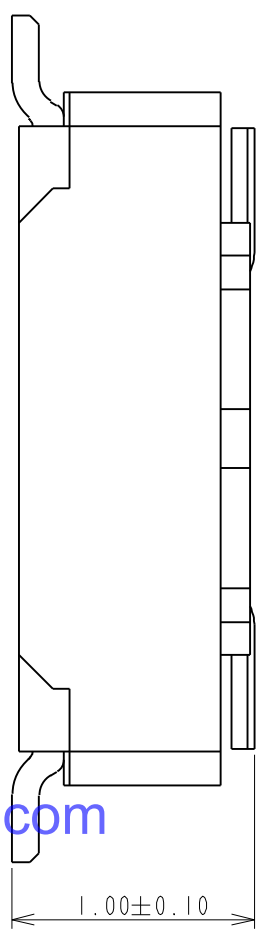

PRODUCT NUMBERING CODE:
 BBR43 - XX K X 5 X X
 1 2 3 4 5 6 7

1. PRODUCTION CODE:
 BBR43: BOARD TO BOARD 0.4 PITCH RECEPTACLE

2. POSITIONS:
 XX: POSITIONS(SEE TABLE A)

3. INSULATOR COLOR:
 K: BLACK

4. CONTACT PLATING:
 1: GOLD 10u" MIN
 2: GOLD 5u" MIN
 3: GOLD 10u" MIN
 B: GOLD 4u" MIN FOR SPOT PLATING
 ALL OVER: NI 50~100u"

5. TYPE OF HEIGHT:
 5: H=0.77mm

6. TYPE OF HOLD DOWN:
 3: WITHOUT HOLD DOWN

7. OTHER
 2: WITH POST, FINISHED PRODUCTS
 3: WITHOUT POST, FINISHED PRODUCTS

www.KaiLapTech.com

www.KaiLapTech.com

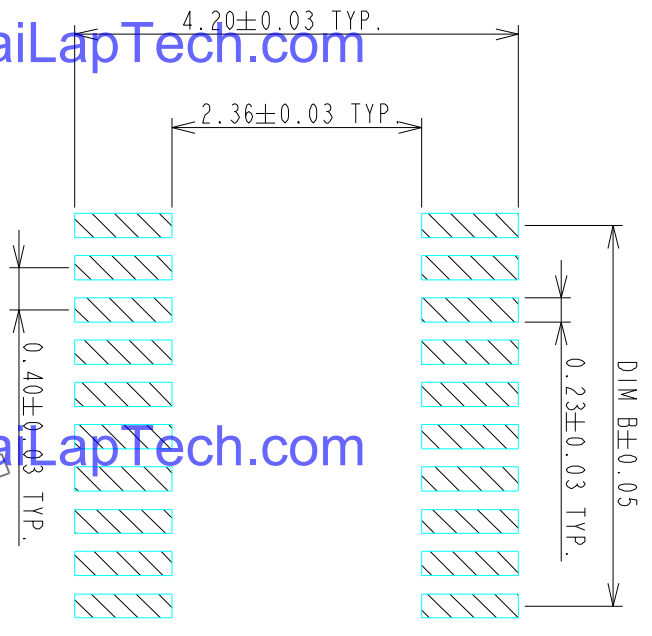

RECOMMENDED P.C. BOARD PATTERN DIMENSION (WITHOUT HOLD DOWN)

NOTES:
 1.0: RATING:
 1.1: VOLTAGE: 60V AC/DC
 1.2: CURRENT: 0.5 AMPS
 1.3: OPERATION TEMPERATURE: -40°C TO +85°C
 2.0: ELECTRICAL CHARACTERISTIC:
 2.1: CONTACT RESISTANCE: 50 mΩ MAX INITIAL
 2.2: INSULATION RESISTANCE: 1000 MΩ MIN INITIAL
 2.3: DIELECTRIC WITHSTANDING VOLTAGE: 250V AC FOR ONE MINUTE
 3.0 TOLERANCES UNLESS OTHERWISE SPECIFIED
 GENERAL: DIMENSION >10.00 ±0.13
 DIMENSION 5.00~10.00 ±0.10
 DIMENSION <5.00 ±0.05

www.KaiLapTech.com

www.KaiLapTech.com

www.KaiLapTech.com

www.KaiLapTech.com

TABLE A:

POSITIONS	DIM A	DIM B	DIM C
10	4.61	1.60	3.71
14	5.41	2.40	4.51
16	5.81	2.80	4.91
18	6.21	3.20	5.31
20	6.61	3.60	5.71
22	7.01	4.00	6.11
24	7.41	4.40	6.51
26	7.81	4.80	6.91
30	8.61	5.60	7.71
32	9.01	6.00	8.11
34	9.41	6.40	8.51
40	10.61	7.60	9.71
44	11.41	8.4	10.51
48	12.21	9.20	11.31
50	12.61	9.60	11.71
54	13.41	10.40	12.51
60	14.61	11.60	13.71
70	16.61	13.60	15.71
80	18.61	15.60	17.71

4.0 ALL COPPLANARITY IS 0.08mm MAX. BEFORE REFLOW
 ALL COPPLANARITY IS 0.10mm MAX. AFTER REFLOW

TOLERANCES UNLESS OTHERWISE SPECIFIED		DRAWN		DATE	
GENERAL X	±0.38	RAIN	04/15/10		
XXX	±0.13	DESIGN			
ANGLES X°	±0.13	RAIN	04/15/10		
UNIT	MM	CHECKED			
SCALE	20:1	HARDWARE	04/24/10		
SHEET	2 OF 2	APPROVED			
UNIT	MM	DICK. LEE	04/24/10		
		CUSTOMER DRAWING		TITLE	
		SERIES		P0.4*H1.0mm BOARD TO BOARD	
		DWG NO.		ADVANCED-CONNECTEK INC.	
		C-BBR43-04-01		WITHOUT HOLD DOWN	
		REV.		SIZE	
		B		A3	

F

E

D

C

B

A

[Product Brief]

Ver.1.0

IMX258

Diagonal 5.867 mm (Type 1/3.06) 13Mega-Pixel CMOS Image Sensor with Square Pixel for Color Cameras

Description

IMX258 is a diagonal 5.867mm (Type 1/3.06) 13 Mega-pixel CMOS active pixel type stacked image sensor with a square pixel array. It adopts Exmor RSM technology to achieve high speed image capturing by column parallel A/D converter circuits and high sensitivity and low noise image (comparing with conventional CMOS image sensor) through the backside illuminated imaging pixel structure. R, G, and B pigment primary color mosaic filter is employed. By introducing spatially multiplexed exposure technology, high dynamic range still pictures and movies are achievable. It

equips an electronic shutter with variable integration time. It operates with three power supply voltages: analog 2.7 V, digital 1.2 V and 1.8 V for input/output interface and achieves low power consumption.

In addition, this product is designed for use in cellular phone and tablet pc. When using this for another application, Sony does not guarantee the quality and reliability of product. Therefore, don't use this for applications other than cellular phone and tablet pc. Consult your Sony sales representative if you have any questions.

Functions and Features

- ◆ Back-illuminated and stacked CMOS image sensor Exmor RSM
- ◆ Phase Detection pixel data output for Phase Detection Auto Focus
- ◆ High Dynamic Range (HDR) mode with raw data output.
- ◆ High signal to noise ratio (SNR).
- ◆ Full resolution @30fps (Normal / HDR). 4K2K @30fps (Normal / HDR) 1080p @60fps (Normal)
- ◆ Output video format of RAW10/8.
- ◆ Pixel binning readout and V sub-sampling function.
- ◆ Independent flipping and mirroring.
- ◆ CSI-2 serial data output (MIPI 2lane/4lane, Max. 1.3Gbps/lane, D-PHY spec. ver. 1.1 compliant)
- ◆ 2-wire serial communication.
- ◆ Two PLLs for independent clock generation for pixel control and data output interface.
- ◆ Dynamic Defect Pixel Correction.
- ◆ Fast mode transition. (on the fly)
- ◆ Dual sensor synchronization operation.
- ◆ 4K bit of OTP ROM for users.
- ◆ Built-in temperature sensor.

Device Structure

- ◆ CMOS image sensor
- ◆ Image size : Diagonal 5.867 mm (Type 1/3.06)
- ◆ Total number of pixels : 4224 (H) × 3192 (V) approx. 13.48 M pixels
- ◆ Number of effective pixels : 4224 (H) × 3144 (V) approx. 13.28 M pixels
- ◆ Number of active pixels : 4208 (H) × 3120 (V) approx. 13.13 M pixels
- ◆ Chip size : 5.990 mm (H) × 3.908 mm (V)
- ◆ Unit cell size : 1.12 μm (H) × 1.12 μm (V)
- ◆ Substrate material : Silicon

System block diagram

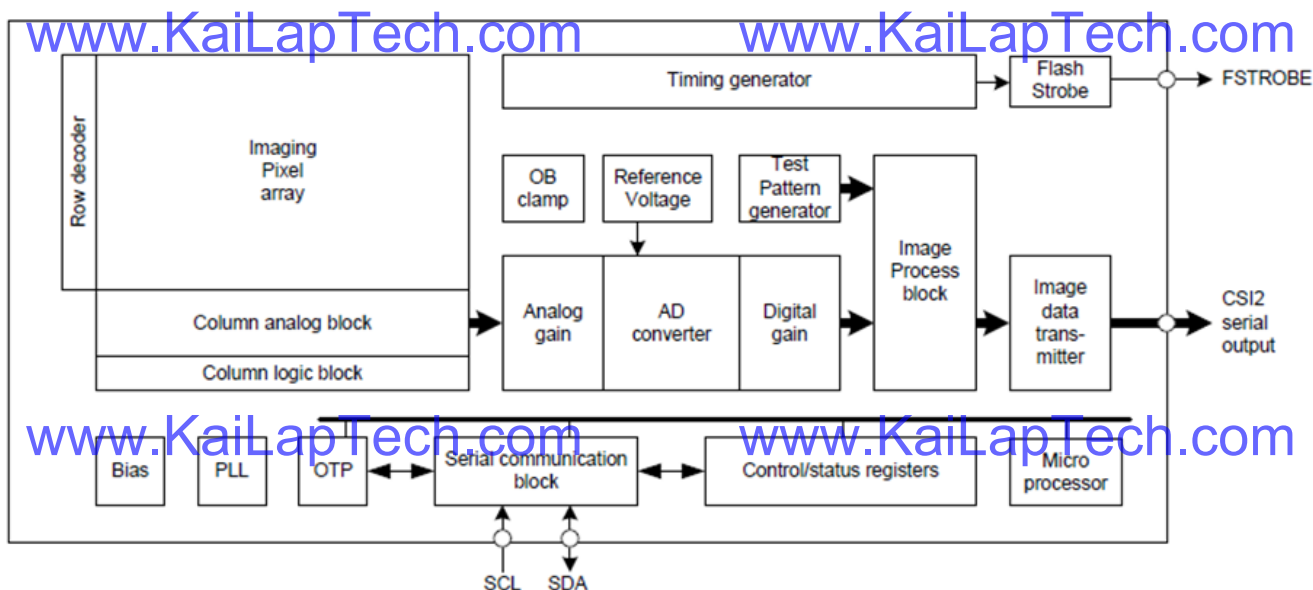

www.KaiLapTech.com

www.KaiLapTech.com

Exmor RS

* Exmor RS is a trademark of Sony Corporation. The Exmor RS is a Sony's CMOS image sensor with high-resolution, high-performance and compact size by replacing a supporting substrate in Exmor R™ which changed fundamental structure of Exmor™ pixel adopted column parallel A/D converter to back-illuminated type, with layered chips formed signal processing circuits.



Camera Module Pinout Definition Reference Chart

OmniVision	Sony	Samsung	On-Semi	Aptina	Himax	GalaxyCore	PixArt	SmartSens	Sensors
Pin Signal		Description							
DGND GND		ground for digital circuit							
AGND		ground for analog circuit							
PCLK DCK		DVP PCLK output							
XCLR PWDN XSHUTDOWN STANDBY		power down active high with internal pull-down resistor							
MCLK XVCLK XCLK INCK		system input clock							
RESET RST		reset active low with internal pull-up resistor							
NC NULL		no connect							
SDA SIO_D SIOD		SCCB data							
SCL SIO_C SIOC		SCCB input clock							
VSYNC XVS FSYNC		DVP VSYNC output							
HREF XHS		DVP HREF output							
DOVDD		power for I/O circuit							
AFVDD		power for VCM circuit							
AVDD		power for analog circuit							
DVDD		power for digital circuit							
STROBE FSTROBE		strobe output							
FSIN		synchronize the VSYNC signal from the other sensor							
SID		SCCB last bit ID input							
ILPWM		mechanical shutter output indicator							
FREQ		frame exposure / mechanical shutter							
GPIO		general purpose inputs							
SLASEL		I2C slave address select							
AFEN		CEN chip enable active high on VCM driver IC							
MIPI Interface									
MDN0 DN0 MD0N DATA_N DMO1N		MIPI 1st data lane negative output							
MDP0 DP0 MD0P DATA_P DMO1P		MIPI 1st data lane positive output							
MDN1 DN1 MD1N DATA2_N DMO2N		MIPI 2nd data lane negative output							
MDP1 DP1 MD1P DATA2_P DMO2P		MIPI 2nd data lane positive output							
MDN2 DN2 MD2N DATA3_N DMO3N		MIPI 3rd data lane negative output							
MDP2 DP2 MD2P DATA3_P DMO3P		MIPI 3rd data lane positive output							
MDN3 DN3 MD3N DATA4_N DMO4N		MIPI 4th data lane negative output							
MDP3 DP3 MD3P DATA4_P DMO4P		MIPI 4th data lane positive output							
MCN CLKN CLK_N DCKN		MIPI clock negative output							
MCP CLKP MCP CLK_P DCKN		MIPI clock positive output							
DVP Parallel Interface									
D0 DO0 Y0		DVP data output port 0							
D1 DO1 Y1		DVP data output port 1							
D2 DO2 Y2		DVP data output port 2							
D3 DO3 Y3		DVP data output port 3							
D4 DO4 Y4		DVP data output port 4							
D5 DO5 Y5		DVP data output port 5							
D6 DO6 Y6		DVP data output port 6							
D7 DO7 Y7		DVP data output port 7							
D8 DO8 Y8		DVP data output port 8							
D9 DO9 Y9		DVP data output port 9							
D10 DO10 Y10		DVP data output port 10							
D11 DO11 Y11		DVP data output port 11							



your **BEST** camera module partner

Cameras Applications



www.KaiLapTech.com



www.KaiLapTech.com



www.KaiLapTech.com

www.KaiLapTech.com



www.KaiLapTech.com



www.KaiLapTech.com





Camera Reliability Test

Reliability Inspection Item		Testing Method	Acceptance Criteria	
Category	Item			
Environmental	Storage Temperature	High 60°C 96 Hours	Temperature Chamber	No Abnormal Situation
		Low -20°C 96 Hours	Temperature Chamber	No Abnormal Situation
	Operation Temperature	High 60°C 24 Hours	Temperature Chamber	No Abnormal Situation
		Low -20°C 24 Hours	Temperature Chamber	No Abnormal Situation
	Humidity	60°C 80% 24 Hours	Temperature Chamber	No Abnormal Situation
	Thermal Shock	High 60°C 0.5 Hours Low -20°C 0.5 Hours Cycling in 24 Hours	Temperature Chamber	No Abnormal Situation
Physical	Drop Test (Free Falling)	Without Package 60cm	10 Times on Wood Floor	Electrically Functional
		With Package 60cm	10 Times on Wood Floor	Electrically Functional
	Vibration Test	50Hz X-Axis 2mm 30min	Vibration Table	Electrically Functional
		50Hz Y-Axis 2mm 30min	Vibration Table	Electrically Functional
		50Hz Z-Axis 2mm 30min	Vibration Table	Electrically Functional
Cable Tensile Strength Test	Loading Weight 4 kg 60 Seconds Cycling in 24 Hours	Tensile Testing Machine	Electrically Functional	
Electrical	ESD Test	Contact Discharge 2 KV	ESD Testing Machine	Electrically Functional
		Air Discharge 4 KV	ESD Testing Machine	Electrically Functional
	Aging Test	On/Off 30 Seconds Cycling in 24 Hours	Power Switch	Electrically Functional
	USB Connector	On/Off 250 Times	Plug and Unplug	Electrically Functional





Inspection Item		Inspection Method	Standard of Inspection	
Category	Item			
Appearance	FPC/ PCB	Color	The Naked Eye	Major Difference is Not Allowed.
		Be Torn/Chopped	The Naked Eye	Copper Crack Exposure is Not Allowed.
		Marking	The Naked Eye	Clear, Recognizable (Within 30cm Distance)
	Holder	Scratches	The Naked Eye	The Inside Crack Exposure is Not Allowed
		Gap	The Naked Eye	Meet the Height Standard
		Screw	The Naked Eye	Make Sure Screws Are Presented (If Any)
		Damage	The Naked Eye	The Inside Crack Exposure is Not Allowed
	Lens	Scratch	The Naked Eye	No Effect On Resolution Standard
		Contamination	The Naked Eye	No Effect On Resolution Standard
		Oil Film	The Naked Eye	No Effect On Resolution Standard
		Cover Tape	The Naked Eye	No Issue On Appearance.
	Function	Image	No Communication	Test Board
Bright Pixel			Black Board	Not Allowed In the Image Center
Dark Pixel			White board	Not Allowed In the Image Center
Blurry			The Naked Eye	Not Allowed
No Image			The Naked Eye	Not Allowed
Vertical Line			The Naked Eye	Not Allowed
Horizontal Line			The Naked Eye	Not Allowed
Light Leakage			The Naked Eye	Not Allowed
Blinking Image			The Naked Eye	Not Allowed
Bruise			Inspection Jig	Not Allowed
Resolution			Chart	Follows Outgoing Inspection Chart Standard
Color			The Naked Eye	No Issue
Noise			The Naked Eye	Not Allowed
Corner Dark			The Naked Eye	Less Than 100px By 100px
Color Resolution			The Naked Eye	No Issue
Dimension	Height	The Naked Eye	Follows Approval Data Sheet	
	Width	The Naked Eye	Follows Approval Data Sheet	
	Length	The Naked Eye	Follows Approval Data Sheet	
	Overall	The Naked Eye	Follows Approval Data Sheet	



KLT Package Solutions

KLT Camera Module



Complete with Lens Protection Film



Tray with Grid and Space



Place Cameras on the Tray





Camera Modules Package Solution

Full Tray of Cameras



Cover Tray with Lid



Put Tray into Anti-Static Bag



Vacuum the Anti-Static Bag





Camera Modules Package Solution

Sealed Vacuum Bag with Labels

- 1. Model and Description 2. Quantity 3. Shipping Date 4. Caution**





CMOS CAMERA MODULES



your BEST camera module partner

Large Order Package Solution

Place Foam Sheets Between Trays

Foam Sheets are Slightly Larger than Trays



www.KaiLapTech.com

www.KaiLapTech.com

Place Foam Sheets and Trays into Box

Foam Sheets are Tightly Fitting Box



www.KaiLapTech.com sales@KaiLapTech.com Tel: (852) 6908 1256 Fax: (852) 3017 6778

All rights reserved @ Kai Lap Technologies Group Ltd. Specifications subject to change without notice.



CMOS CAMERA MODULES



your BEST camera module partner

Small Order Package Solution

Place Foam Sheets and Trays into Small Box



www.KaiLapTech.com

Package in Small Box for Shipment

Foam Sheets are Nicely Fitting the Small Box



www.KaiLapTech.com

Place Small Boxes into Larger Box





your **BEST** camera module partner

Carbon Box Package Solution

Seal the Carbon Box

Final Package Labelled Box



Carbon Box Ready for Shipment

1. Delivery Address and Phone No.
2. Box No. and Ship Date
3. Fragile Caution



Sample Order Package Solution

Place Sample into Small Anti-Static Bag



Place Connectors into Small Ant-Static Bag



Sample Labels on the Small Bag

1. Camera Module or Connector Model
2. Shipping Date and Quantity
3. Caution





Connectors Large Order Package Solution

Connectors in a Wheel



Label Connectors in the Wheel



The Wheel is Perfectly Fitting the Box



Connectors Box Ready for Shipment



Company Kai Lap Technologies (KLT)

Kai Lap Technologies Group Limited. (KLT) was established in 2009, a next-generation technology driven manufacturer specialized in research, design, and produce of audio and video products. KLT is occupying 20,000 square feet automated plants with 100 employees of annual throughput 30,000,000 units cameras.

KLT provides OEM, ODM design, contract manufacturing, and builds the camera products. You may provide the requirements to us, even with a hand draft, our sales and engineering work together to meet your needs. We consider ourselves your last-term partner in developing practical and innovative solutions.

Our team covers everything from initial concept development to mass produced product. KLT specializes in customized camera design, raw material, electronic engineering, firmware/software development, product testing, and packing design. Our experienced strategic supply systems offer a robust and dependable manufacturing capacity for orders of various sizes.

www.KaiLapTech.com

www.KaiLapTech.com



Limited Warranty

KLT provides the following limited warranty if you purchased the Product(s) directly from KLT company or from KLT's website, www.KaiLapTech.com. Product(s) purchased from other sellers or sources are not covered by this Limited Warranty. KLT guarantees that the Product(s) will be free from defects in materials and workmanship under normal use for a period of one (1) year from the date you receive the product ("Warranty Period").

For all Product(s) that contain or develop material defects in materials or workmanship during the Warranty Period, KLT will, at its sole option, either: (i) repair the Product(s); (ii) replace the Product(s) with a new or refurbished Product(s) (replacement Product(s) being of identical model or functional equivalent); or (iii) provide you a refund of the price you paid for the Product(s).

This Limited Warranty of KLT is solely limited to repair and/or replacement on the terms set forth above. KLT is not reliable or responsible for any subsequent events.





CMOS CAMERA MODULES



your BEST camera module partner

KLT Strength

Powerful Factory



Professional Service



Promised Delivery



www.KaiLapTech.com sales@KaiLapTech.com Tel: (852) 6908 1256 Fax: (852) 3017 6778

All rights reserved @ Kai Lap Technologies Group Ltd. Specifications subject to change without notice.